



3 years
product
warranty



ADVANCED FEATURES

- Maintenance Free
- Extended Service Life
- Long Shelf Life
- Deep Discharge Recovery

HIGON DEEP CYCLE GEL BATTERY 12V 200AH

The HIGON 12V Deep Cycle GEL Battery is a versatile battery suitable for standby and cyclic applications in extreme environments. It is maintenance-free and leak-proof, making it a dependable power source for telecommunication systems, security systems, and emergency lighting systems. This battery can prevent damage caused by sudden primary electricity loss. It is also suitable for RVs, boats, medical equipment, and lawnmowers due to its long service life and excellent cycle capacity. Furthermore, its high power-to-weight ratio enables it to provide maximum storage for any solar or wind system. HIGON GEL batteries are manufactured using the finest materials, state-of-the-art production techniques, and the strictest quality control procedures to provide a reliable, convenient, and economical rechargeable battery solution.

HIGON GEL200 (12 VOLT 200AH)

Battery Layout

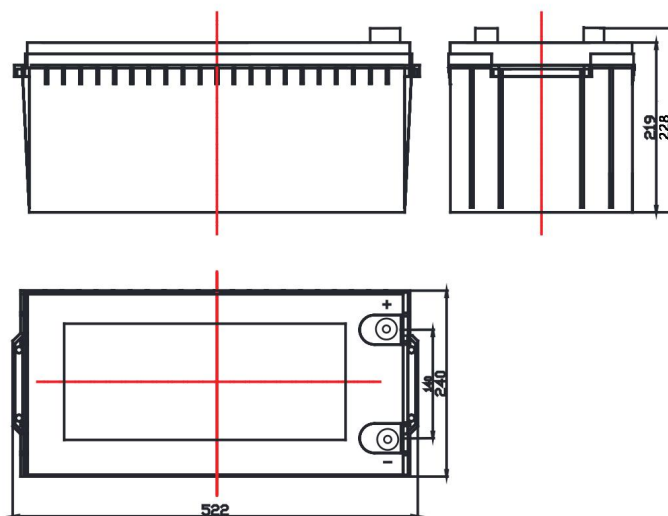

| Rated Voltage | Capacity (10hr,1.80V/Cell) | Weight | Max Discharge Current | Max Charge Current | Self-Discharge (25°C) | Using Temperature | Cover Material |
|---------------|----------------------------|--------|-----------------------|--------------------|-----------------------|-------------------|----------------|
| 12V | 200Ah | 58Kg | 30 I 10A (3min) | ≤0.25 C10 | <3%/month | 15°C-25°C | ABS |

| Using Temperature | Charge Voltage(25°C) | Temperature Compensation Coefficient (25°C) | Cycle life | Capacity Affected by Temperature |
|--|---|---|---|-----------------------------------|
| Discharge: -45°C-50°C Charge: -20°C-45°C Storage: -30°C-40°C | Float Charge: 13.4V-13.7V Average Charge: 14.1-14.4V | Float Temperature Compensation Coefficient -3mV/Cell°C Equalization Temperature Compensation Coefficient -4mV/Cell°C | 100%DOD 572imes 50%DOD 1422times 30%DOD 2218times | 105%@40°C 85%@0°C 60%@-20°C |

Different discharge time at different terminal Voltage, discharge time(Amps,25)

Constant current discharge coefficient (25°C, A)

| Terminal Voltage (V/Cell) | 1H | 3H | 5H | 10H | 20H | 50H | 100H | 120H | 240H |
|---------------------------|--------|-------|-------|-------|-------|------|------|------|------|
| 1.7 | 106.20 | 48.28 | 32.27 | 20.81 | 10.75 | 4.52 | 2.45 | 2.17 | 1.15 |
| 1.75 | 104.08 | 47.96 | 31.69 | 20.52 | 10.50 | 4.35 | 2.29 | 2.03 | 1.07 |
| 1.8 | 102.00 | 43.33 | 31.20 | 20.00 | 10.25 | 4.20 | 2.20 | 1.89 | 1.01 |
| 1.85 | 97.92 | 47.07 | 30.60 | 19.17 | 9.75 | 4.03 | 2.05 | 1.77 | 0.92 |
| 1.9 | 94.01 | 46.65 | 30.15 | 18.77 | 9.58 | 3.91 | 1.99 | 1.69 | 0.87 |
| 1.95 | 89.88 | 45.72 | 29.52 | 17.73 | 8.92 | 3.63 | 1.88 | 1.61 | 0.83 |

HIGON GEL200 (12 VOLT 200AH)

Performance characteristics

Temperature and Service life

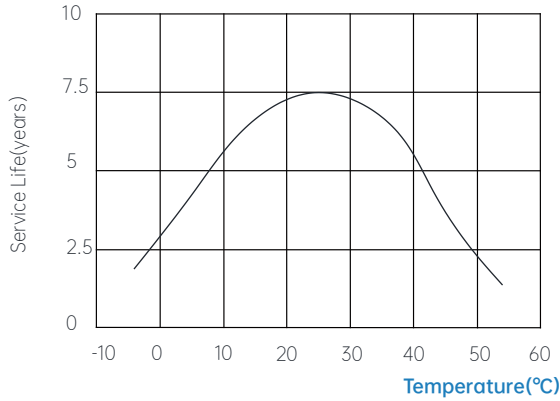

Discharge characteristics at Various Rates (25°C/77°F)

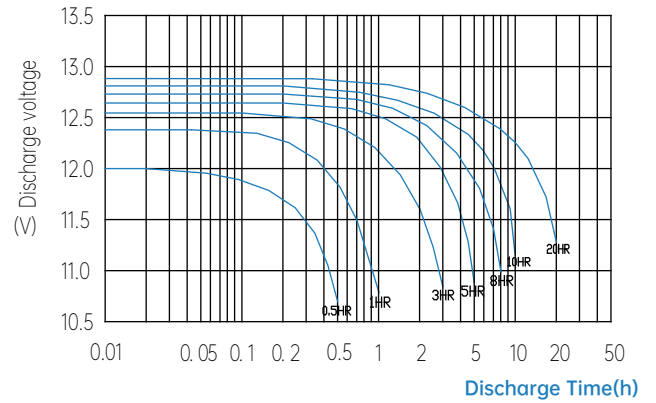

Temperature and discharge capacity

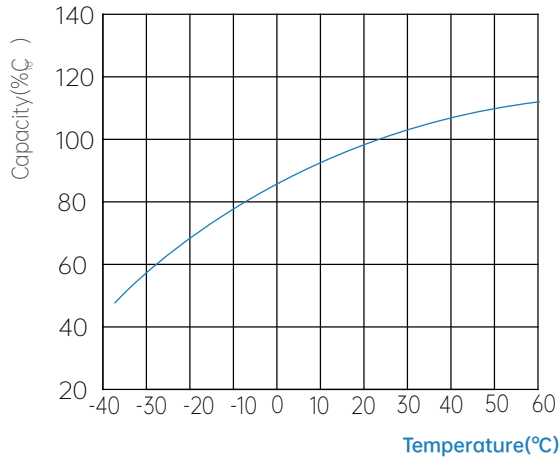

Self discharge parameters characteristics

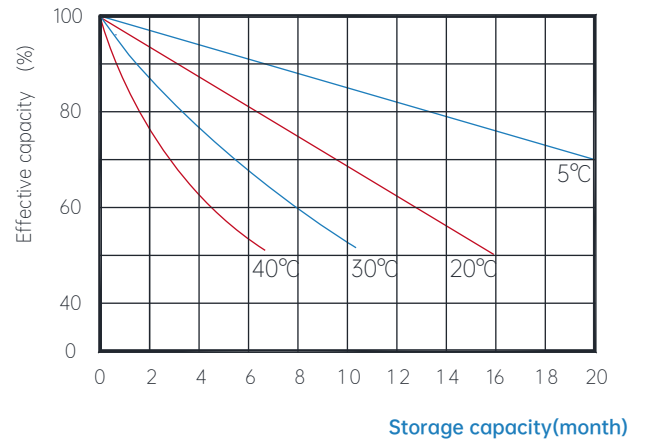

Constant-potential charge

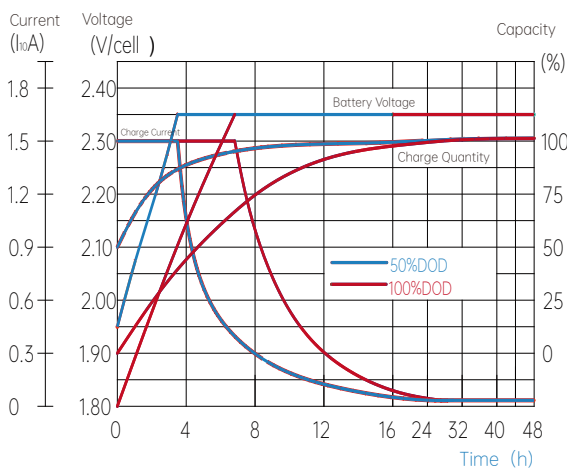

Cycle Service Life (25°C/77°F)

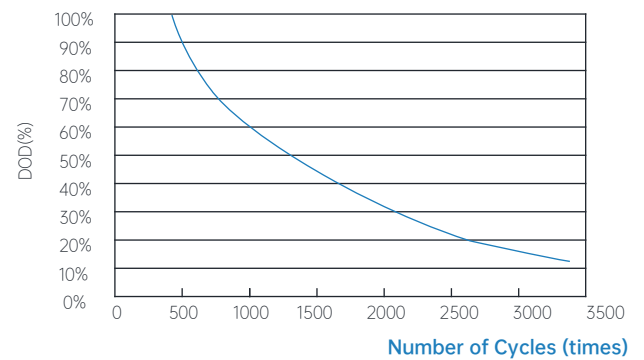

Note The above data are average values, and can be obtained within 3 charge/discharge cycles. These are not minimum values. Cell and battery designs/specifications are subject to modification without notice.

Contact Us for More Information

web: www.higonsolar.com email: info@higonsolar.com

TASTE THE SUN